

# SPAD X

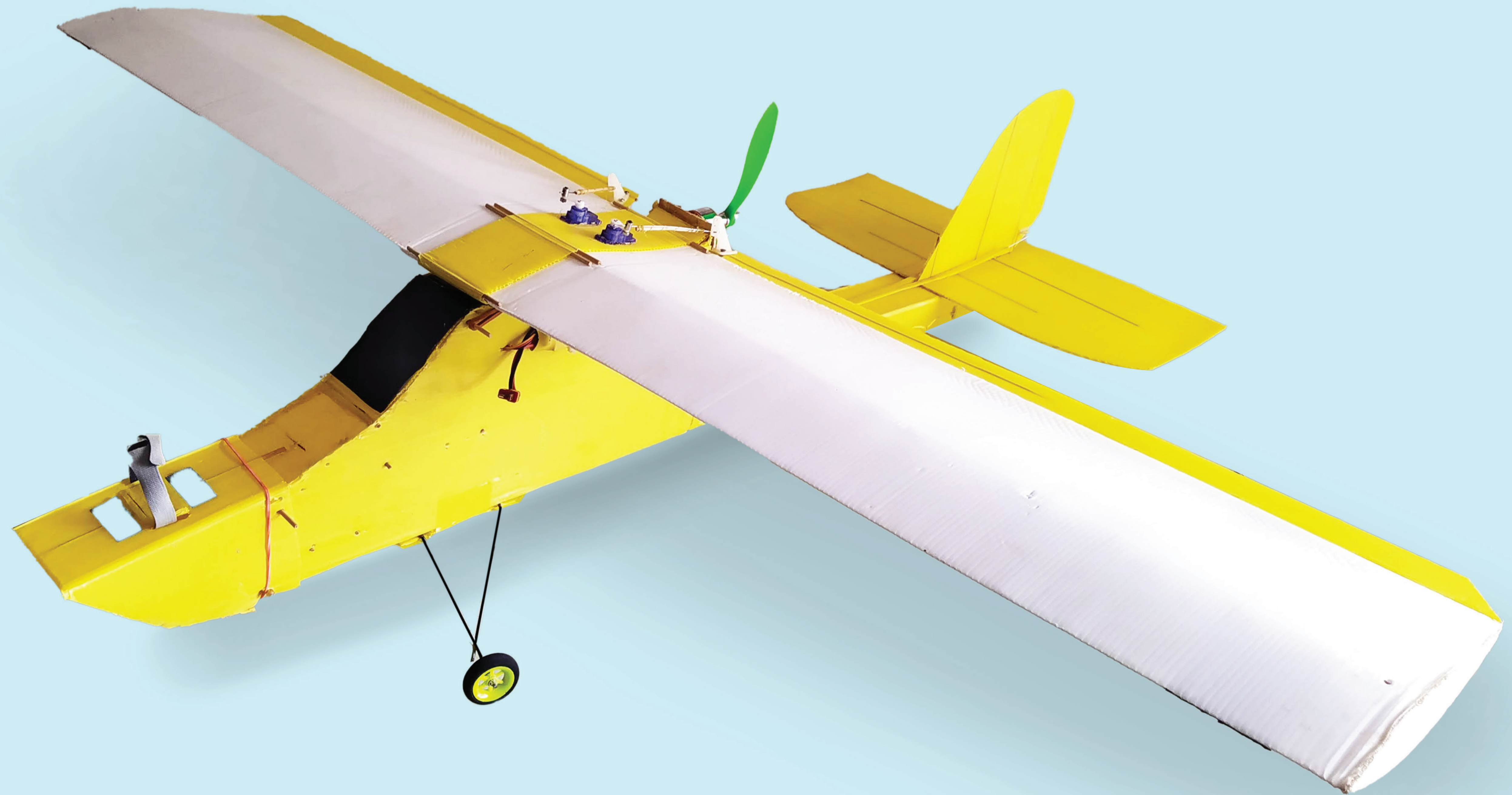

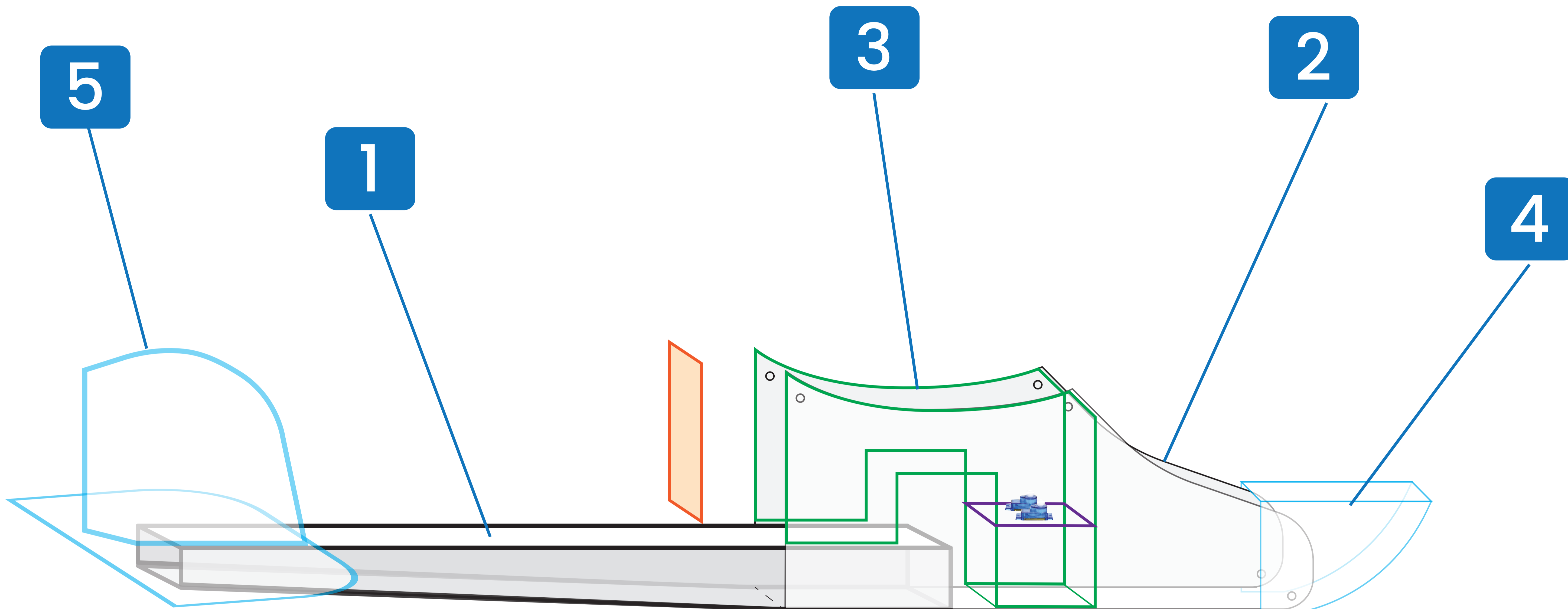

1

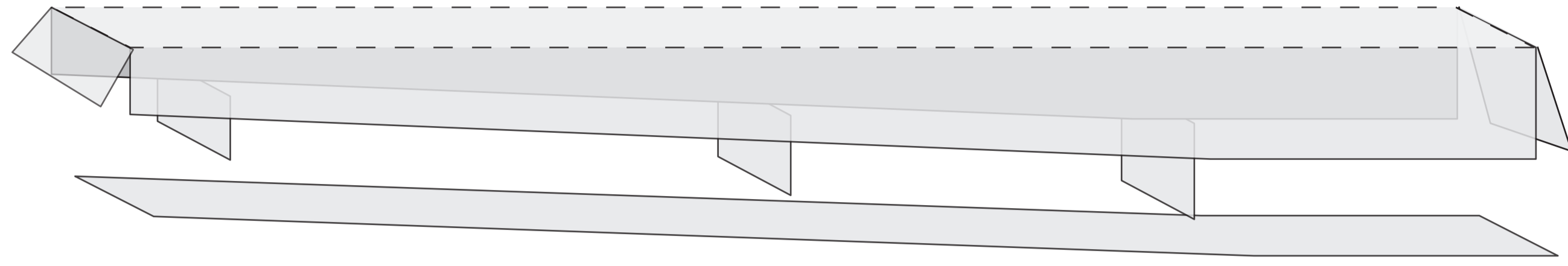

**MATERIAL**  
3 mm  
coroplast

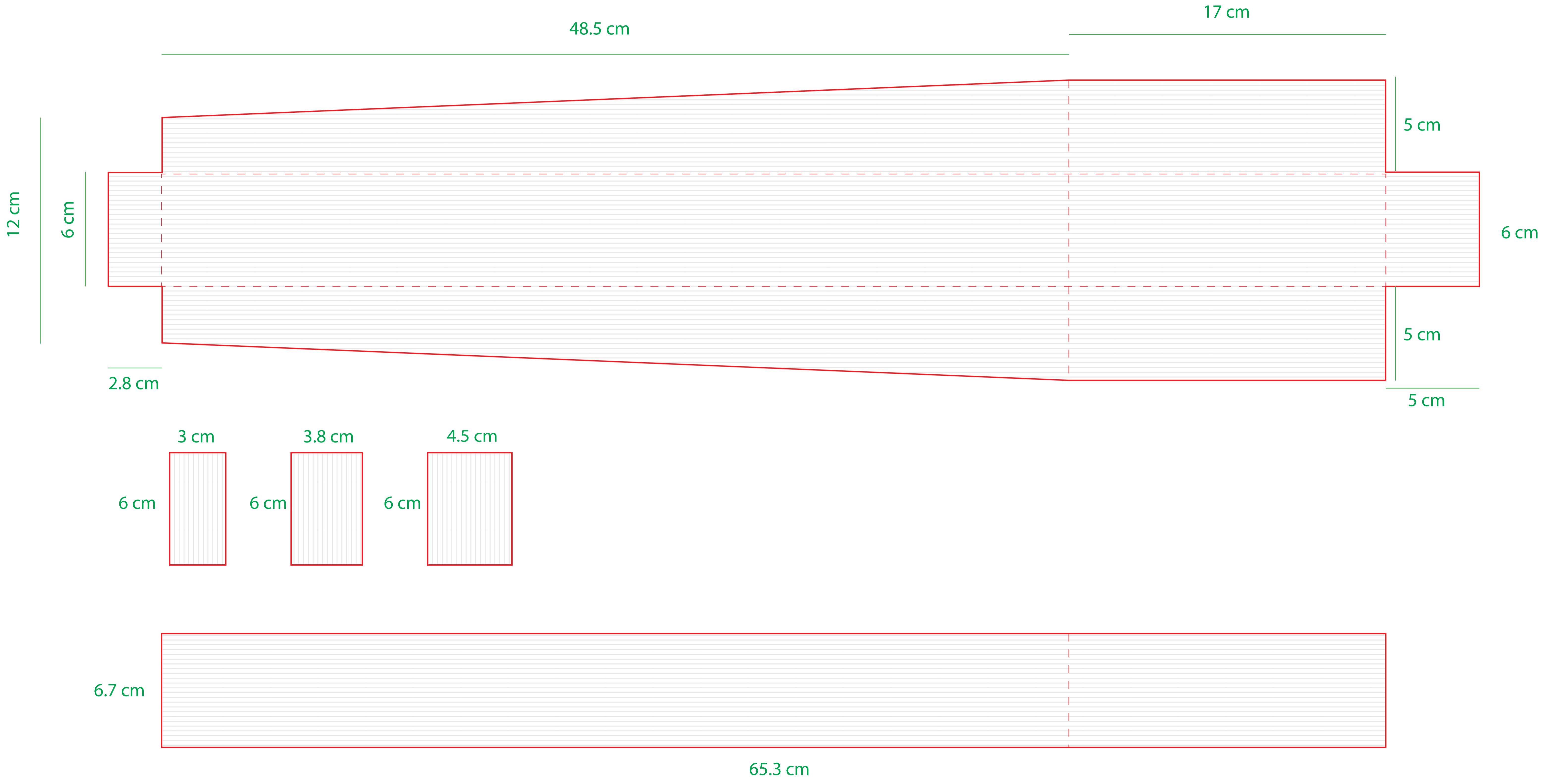

2

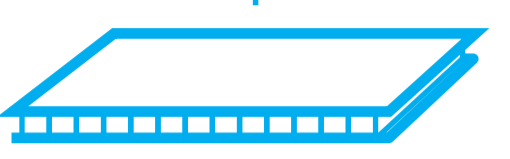
**MATERIAL**  
3 mm coroplast  

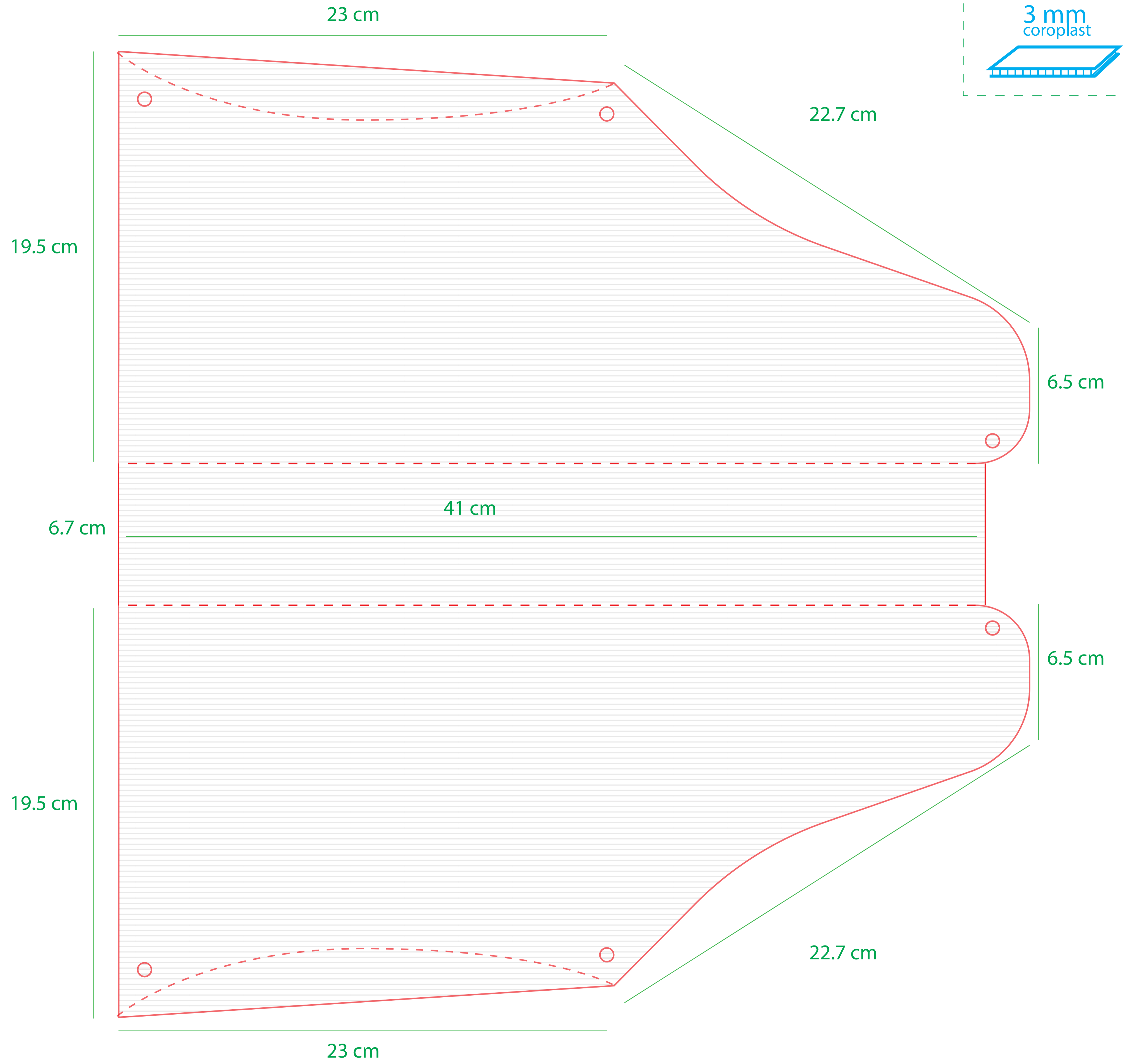
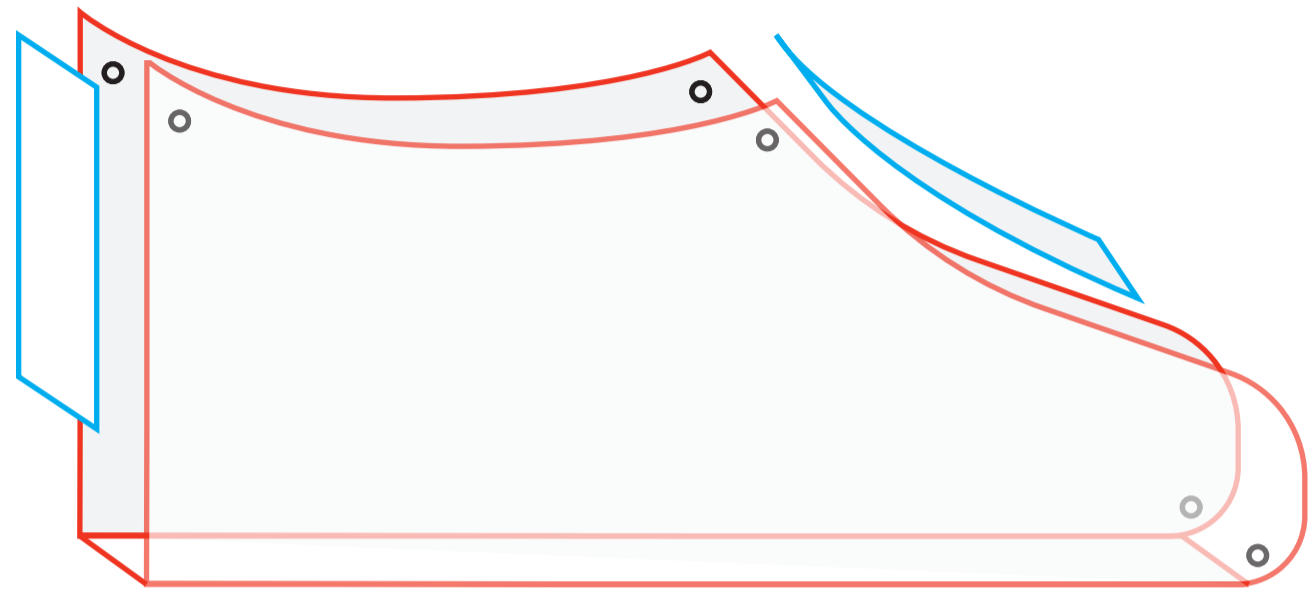

3

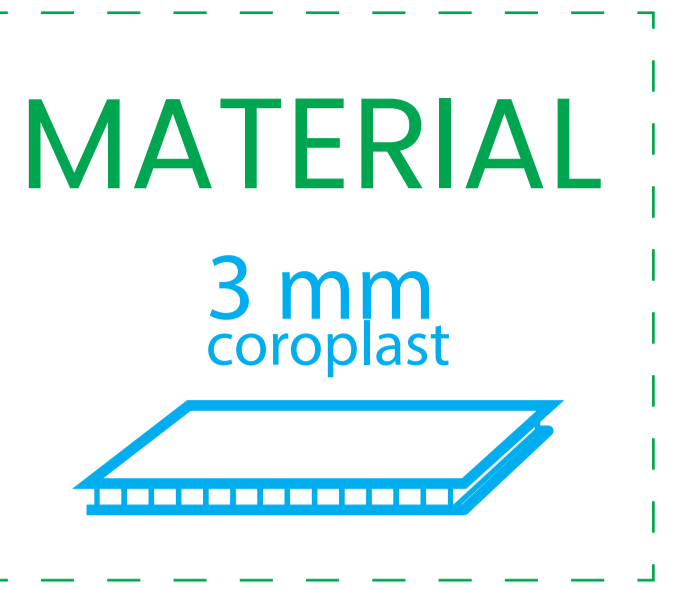
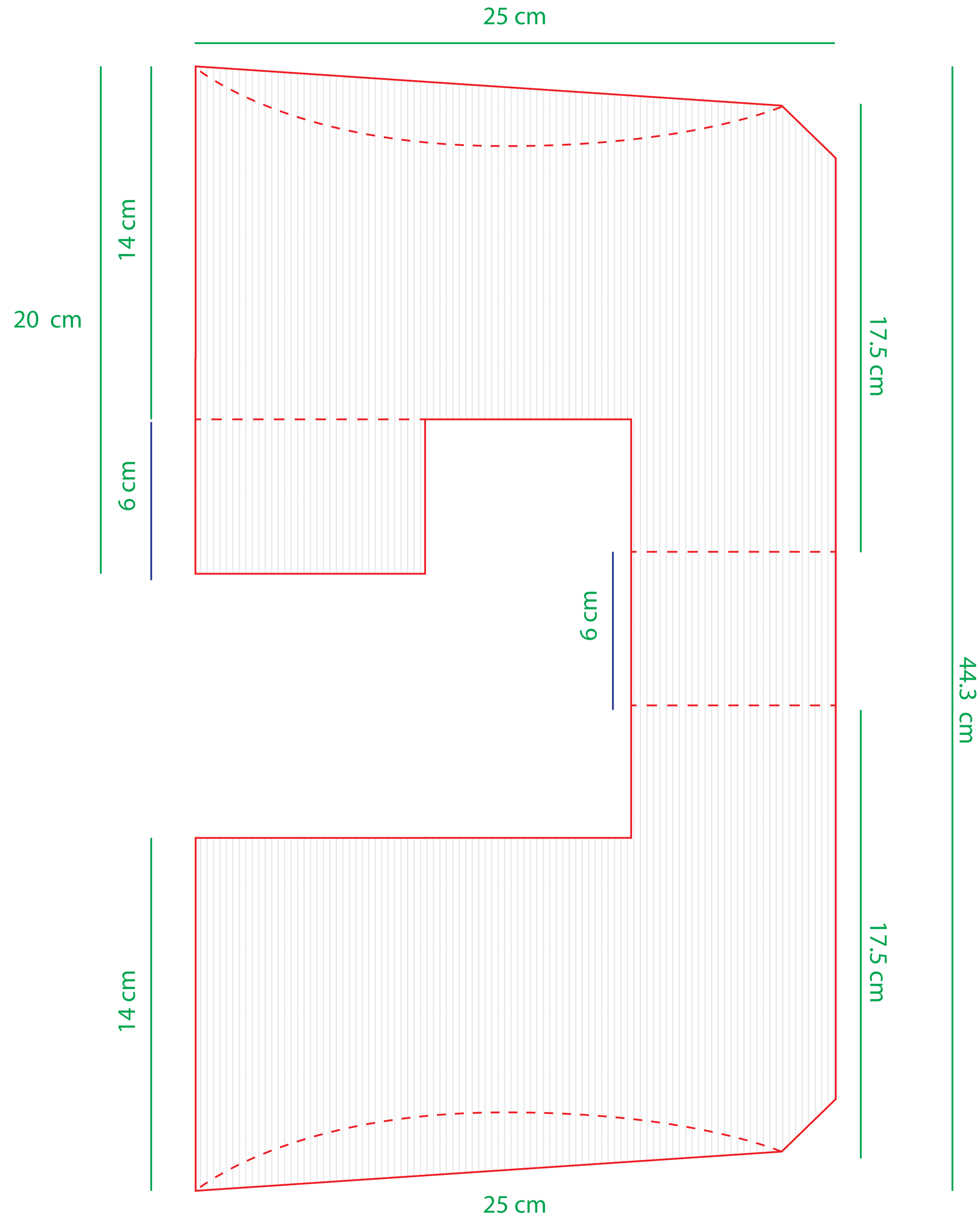
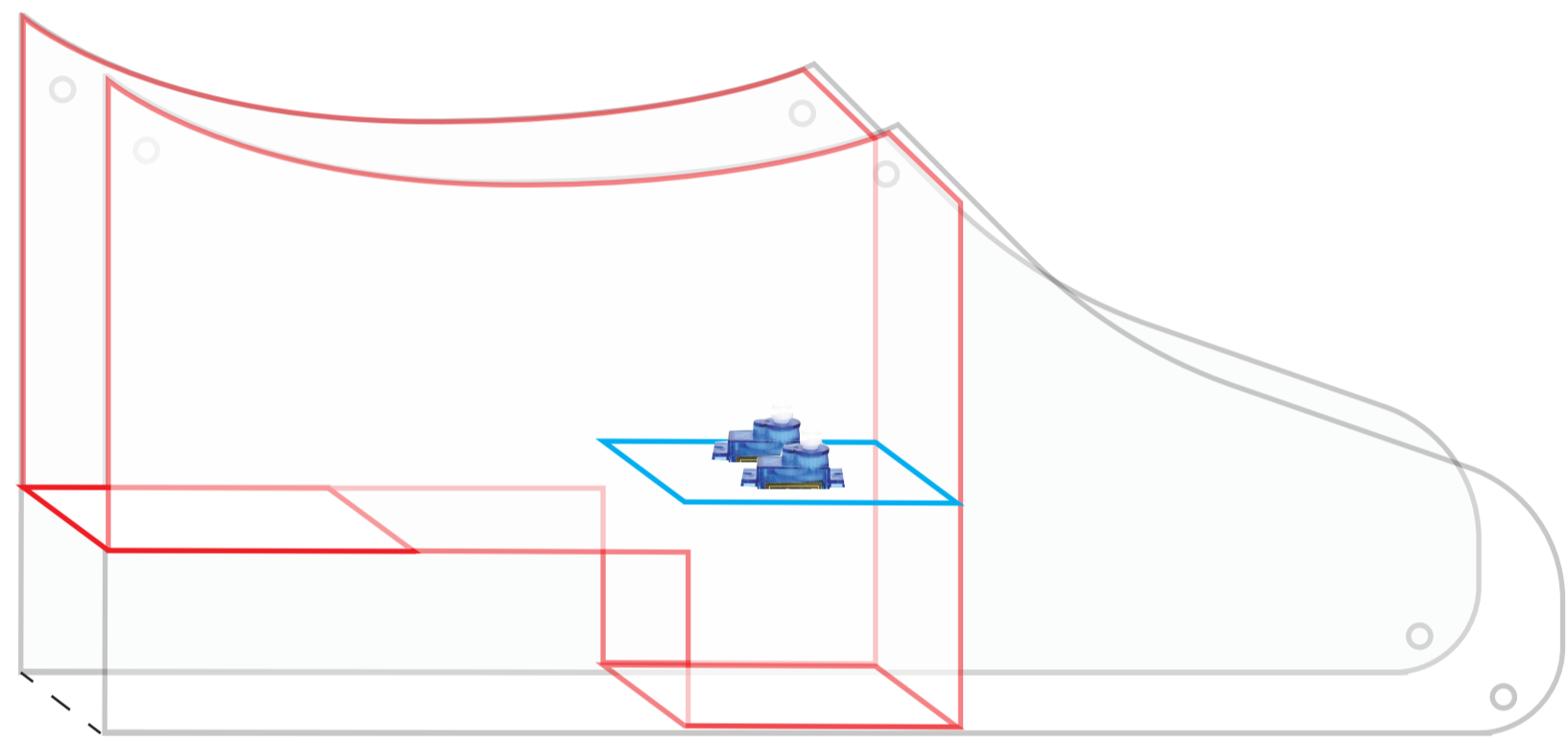

Servo mount

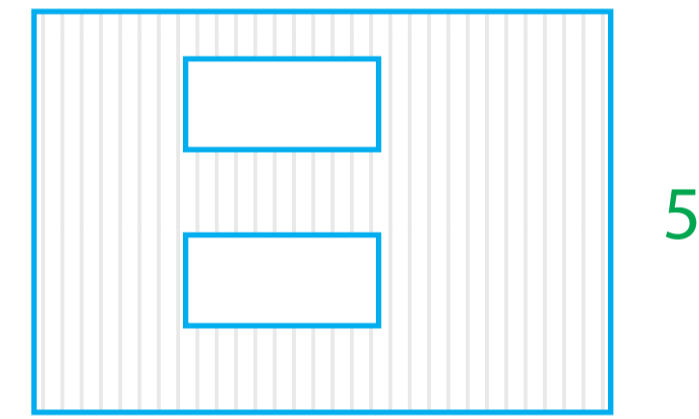

5.3 cm

7.5 cm

4

**MATERIAL**  
3 mm  
coroplast

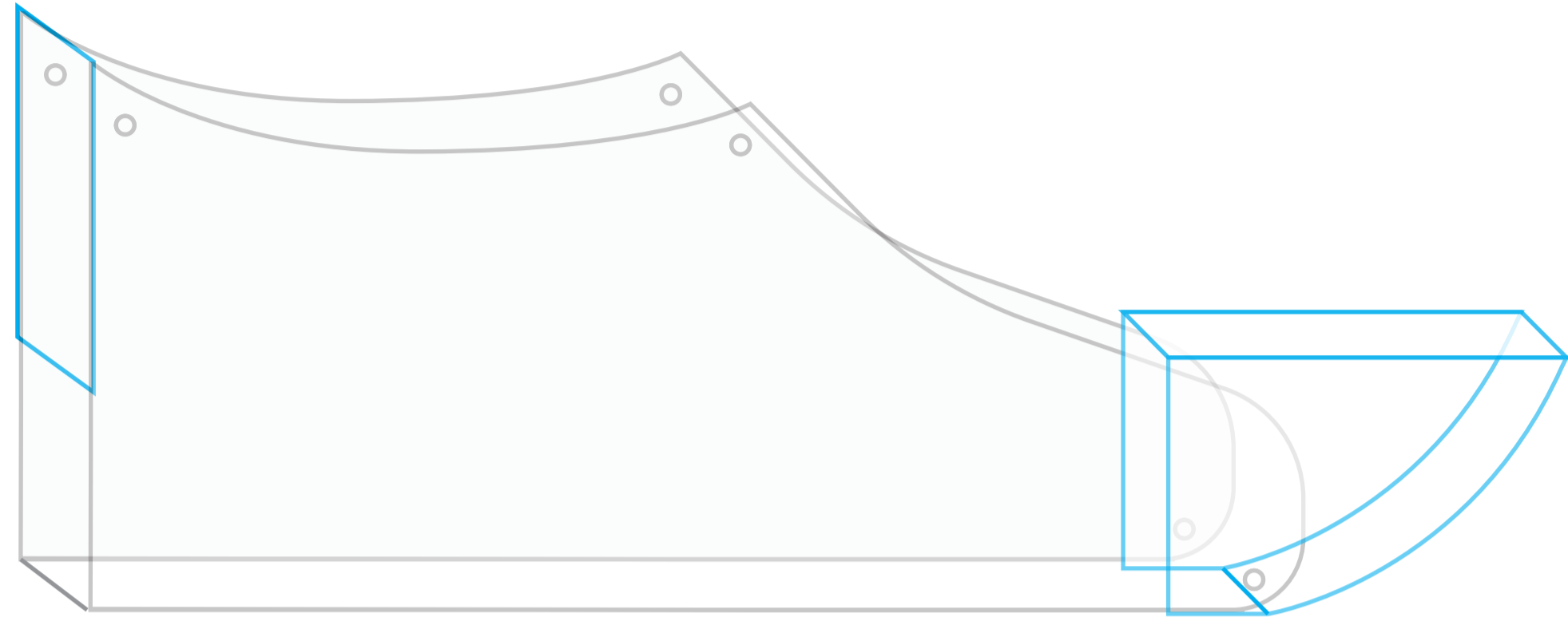
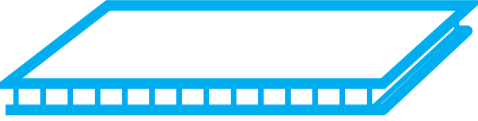

Motor Mount  
on plywood

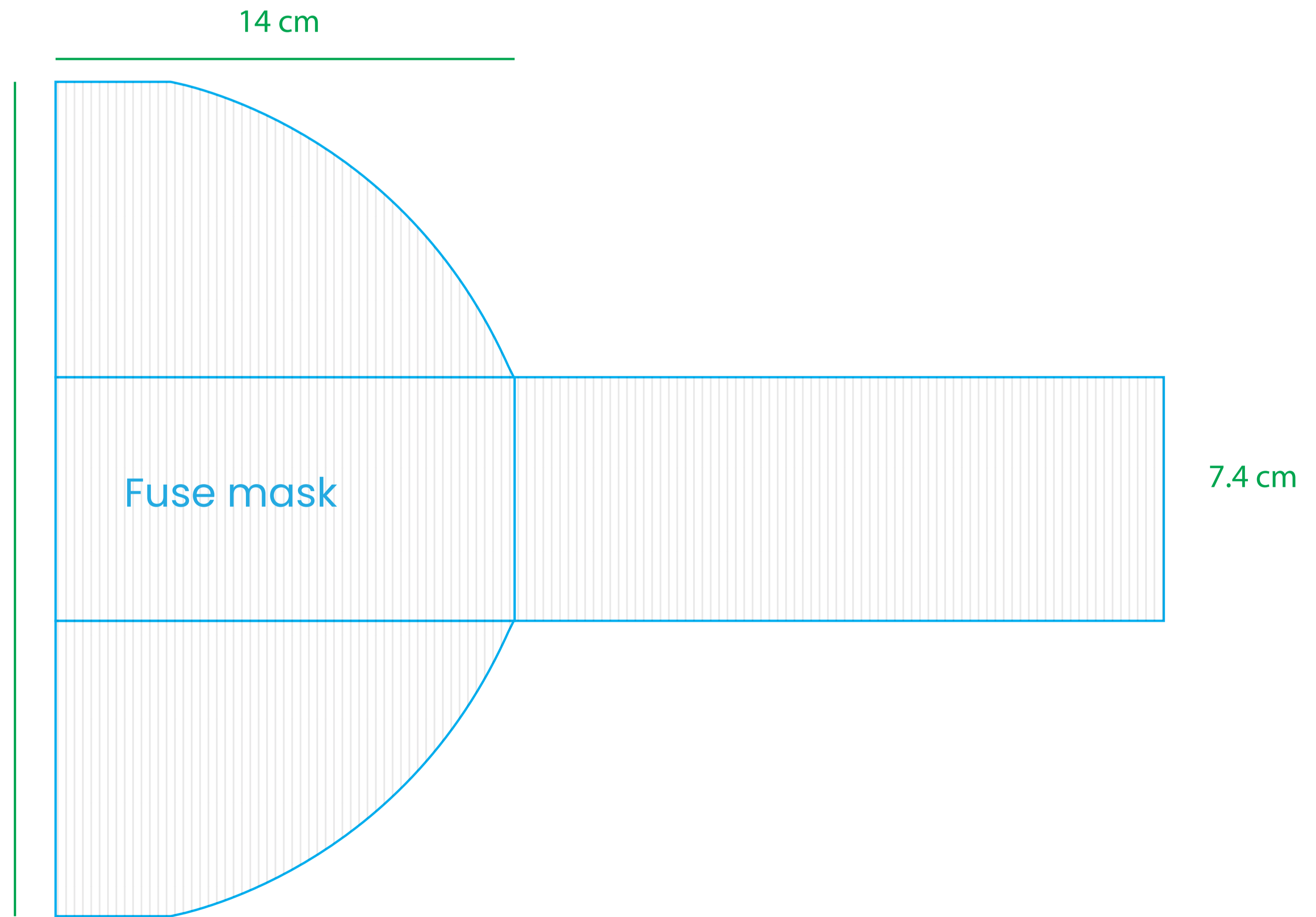
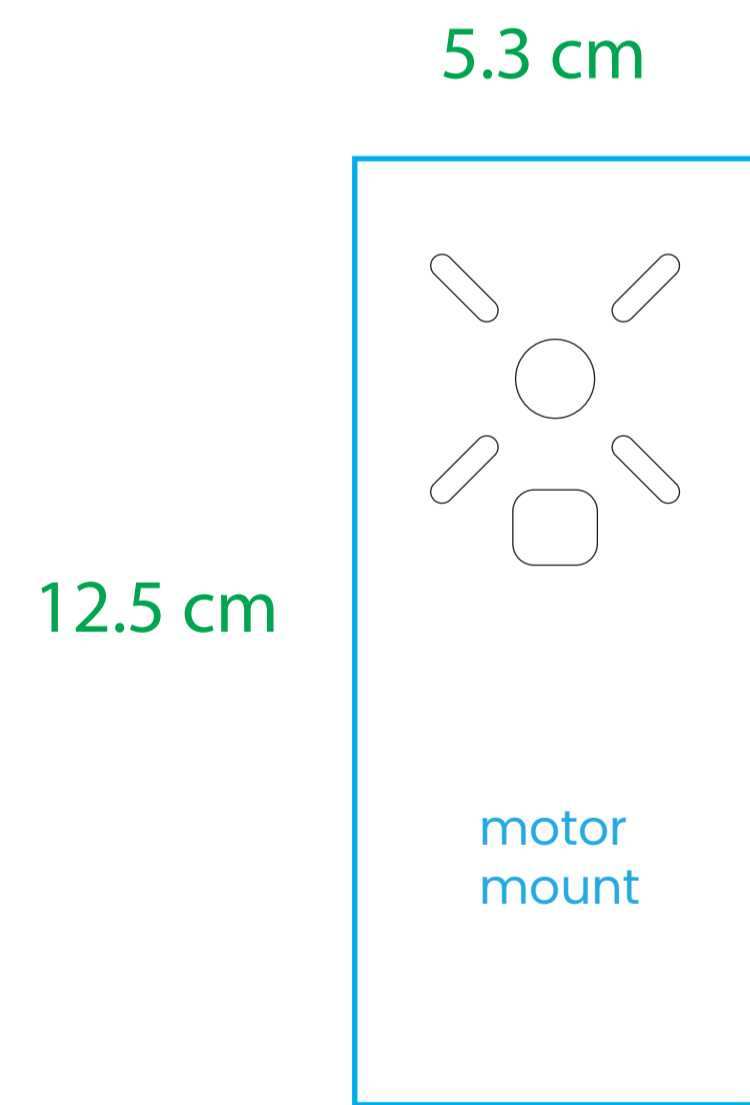

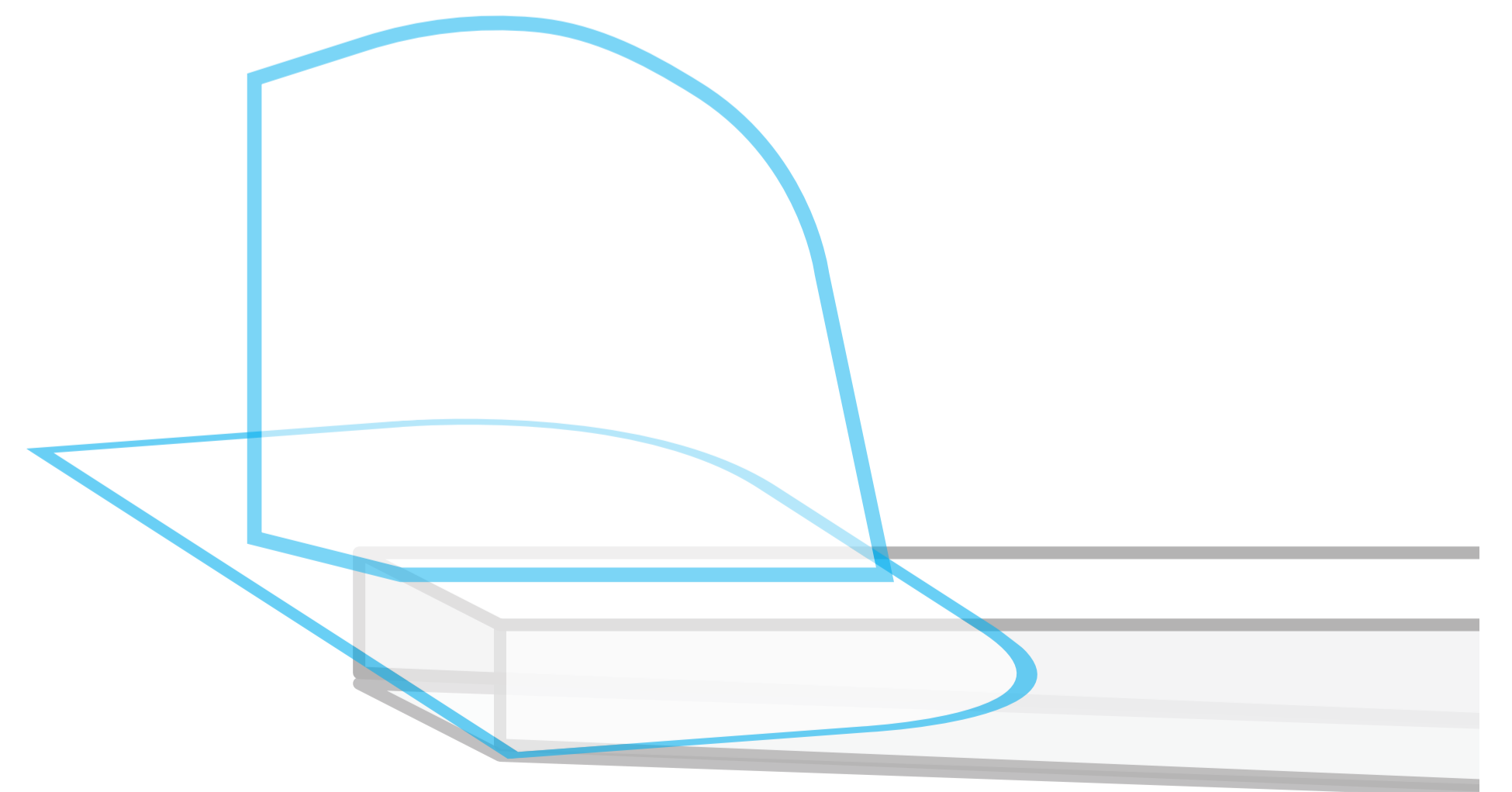
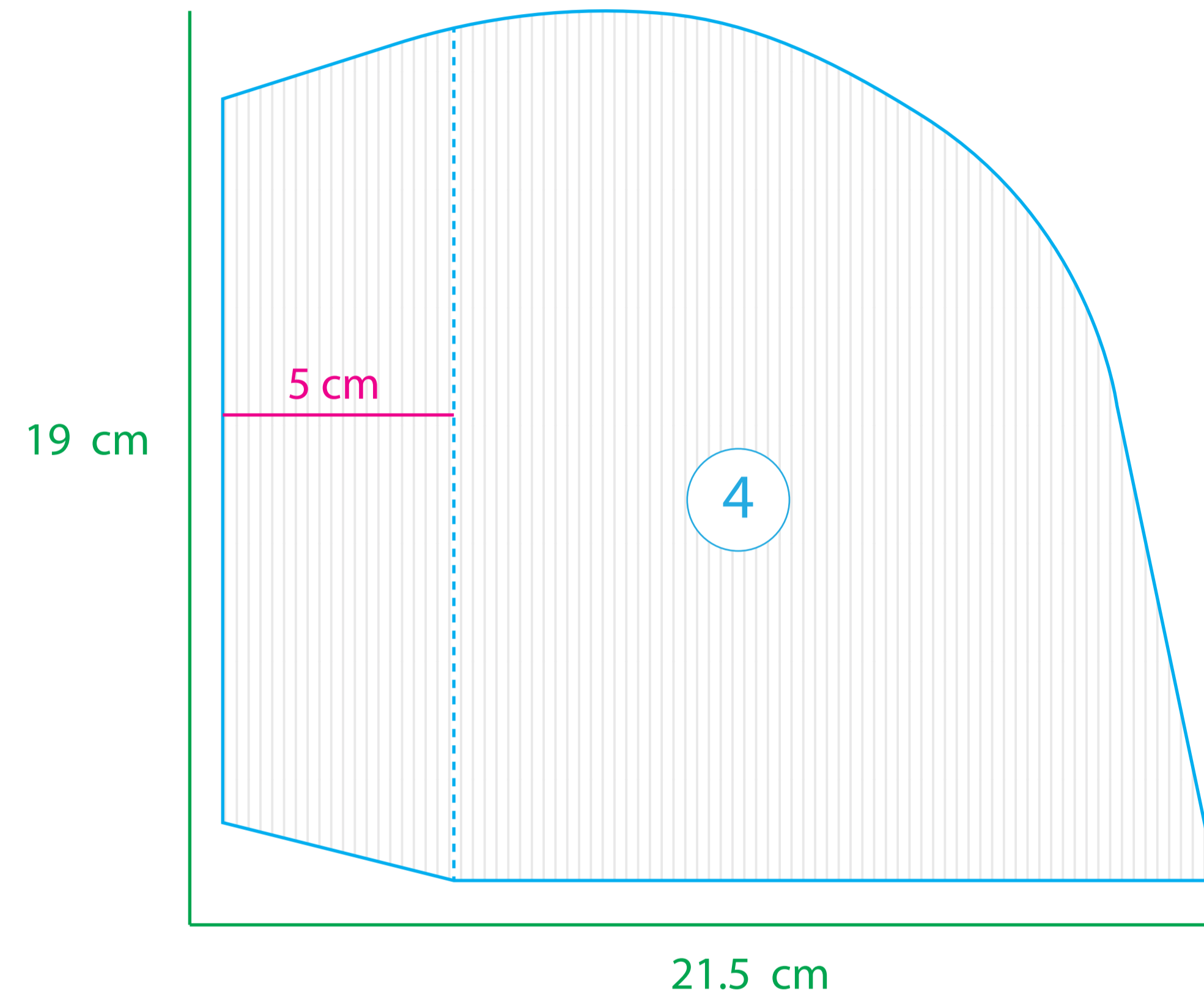
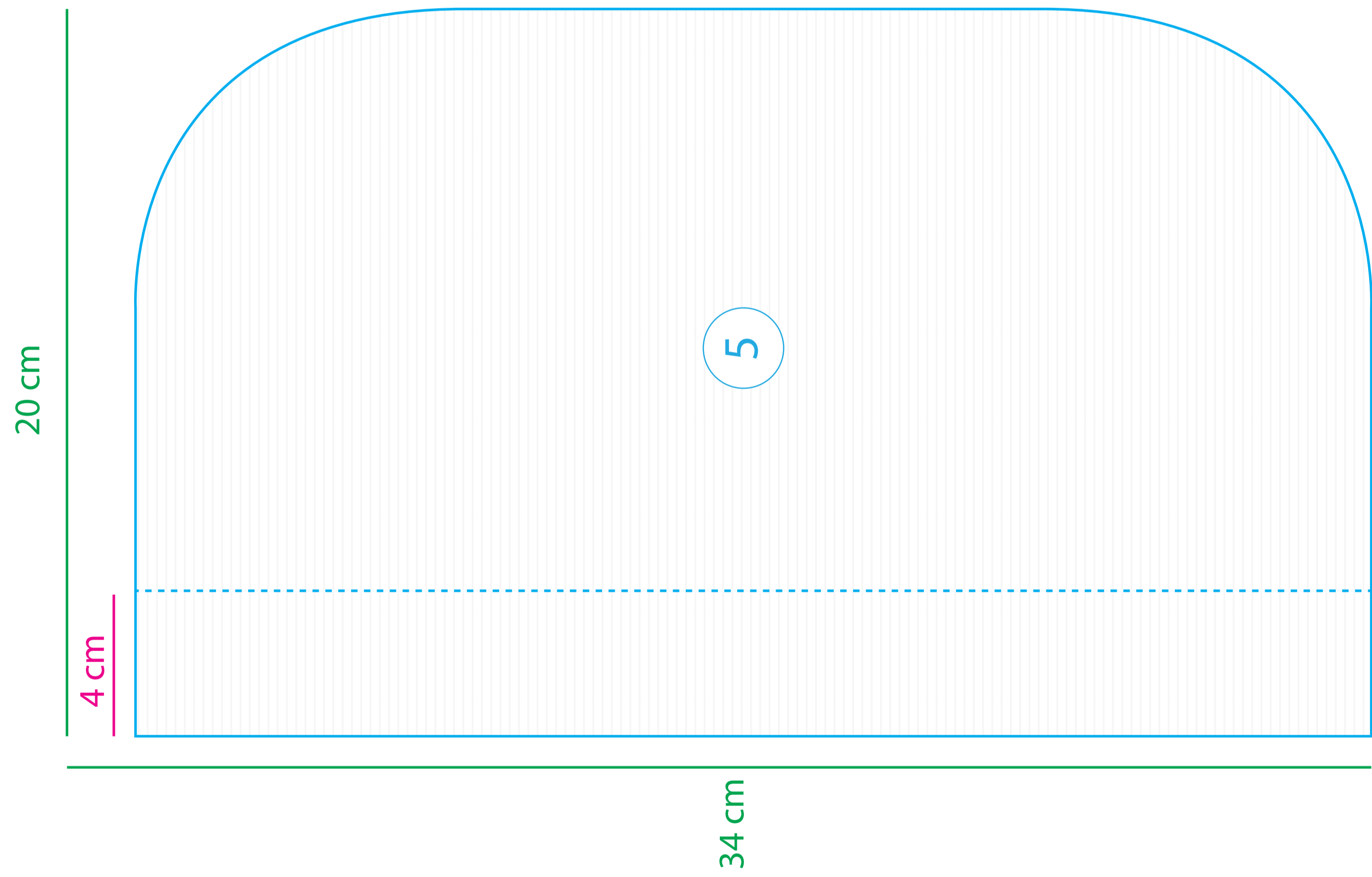

6

MATERIAL  
3 mm  
coroplast

MATERIAL  
2 mm  
coroplast

7

8

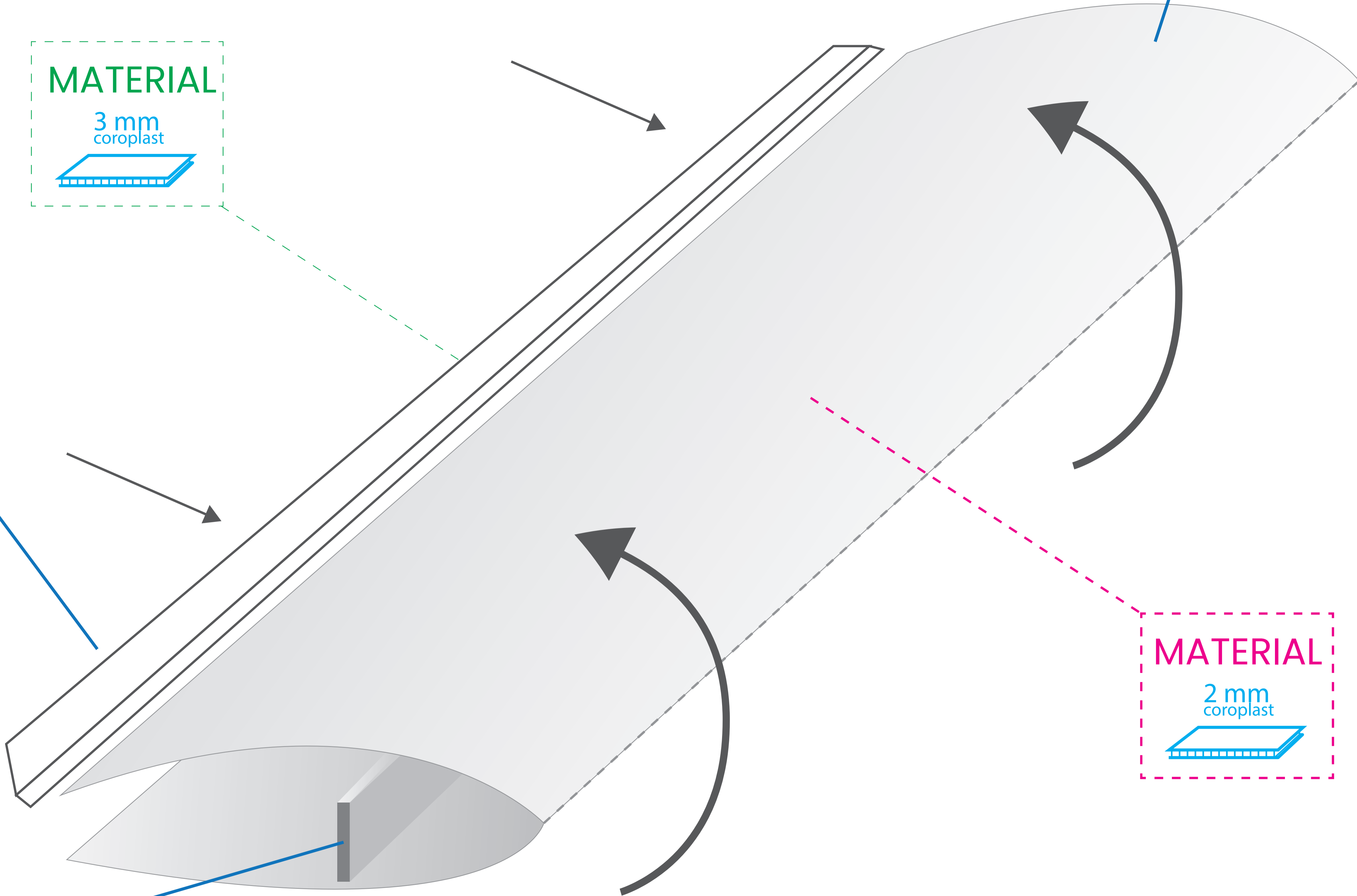

# MATERIAL

2 mm  
coroplast

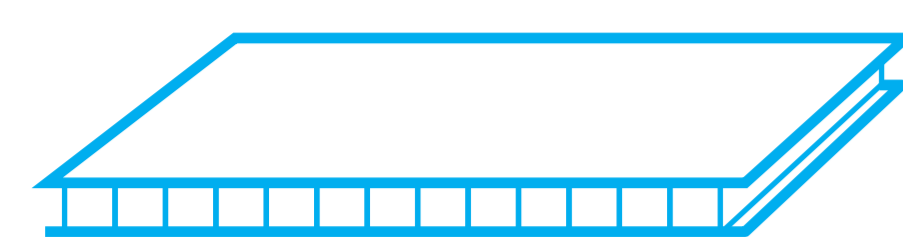

## Main wing

6

21.5 cm

122 cm

5.4 cm SPAR Line

7

1.5 cm  
2.5 cm

2 cm

122 cm

1.5 cm

## Ailerons

8

2.5 cm

122 cm

2.5 cm

2.5 cm

86 cm

## Spars

2.5 cm

2.5 cm

## Servo mounts

7.5 cm

17 cm

47 cm

1 cm

1 cm

7 cm

# MATERIAL

3 mm  
coroplast

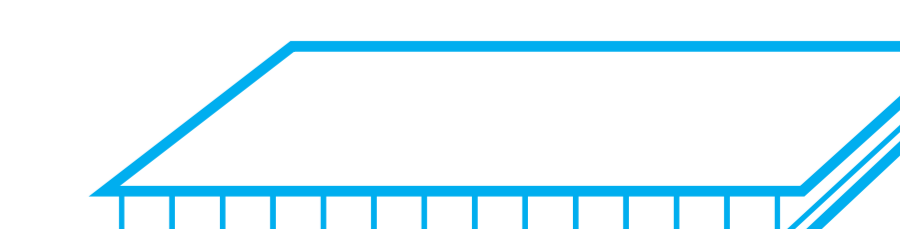



# A4 Print Tiles

(Print in actual 100% size)

AT -1

The image shows a red-outlined form on a page with horizontal grey lines. The form is divided into three main sections. The top section is a trapezoid that is wider on the right side. The middle section is a rectangle with two horizontal dashed red lines. The bottom section is a simple rectangle. The entire form is bounded by two vertical green dashed lines, one on the left and one on the right.

AT -2

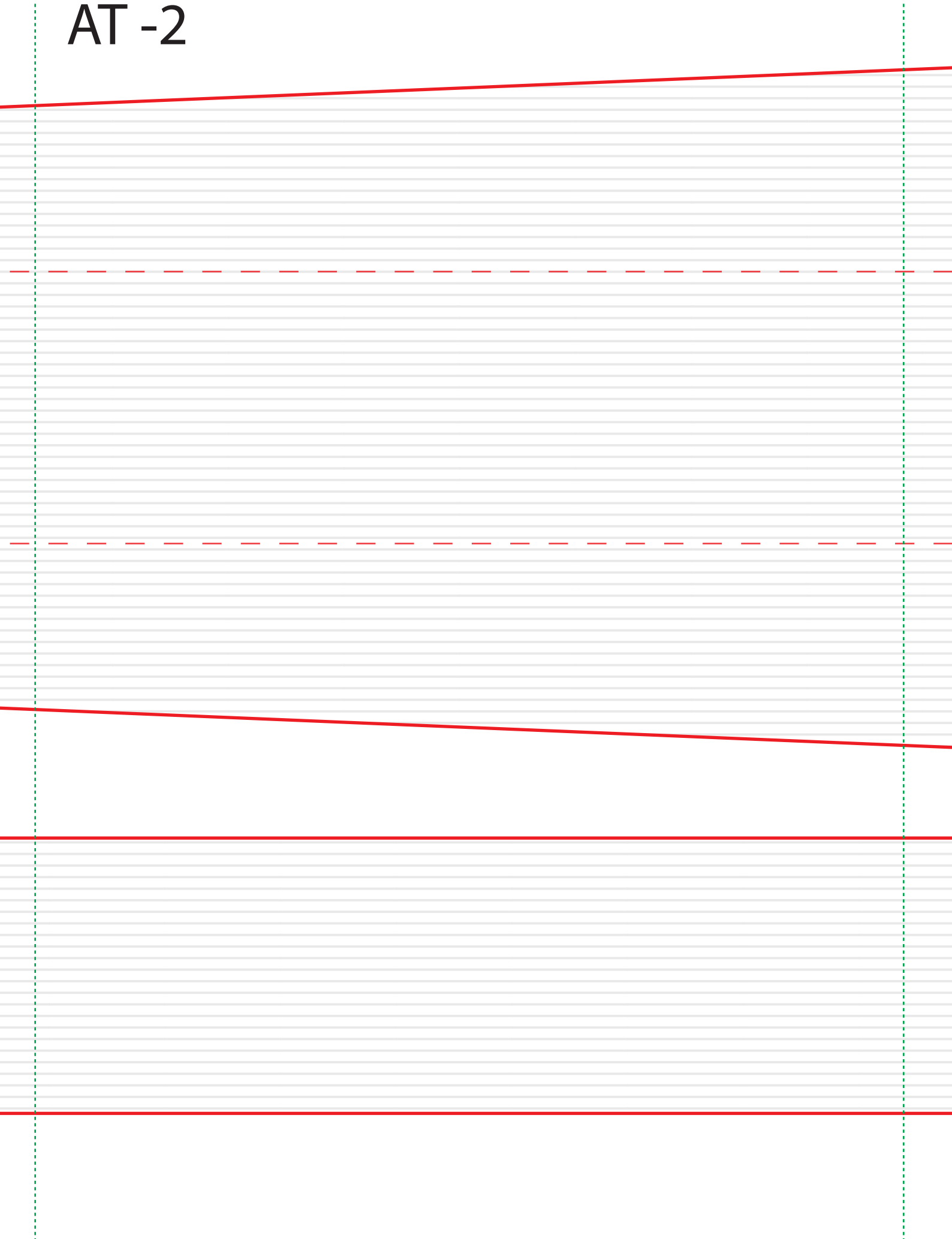

AT -3

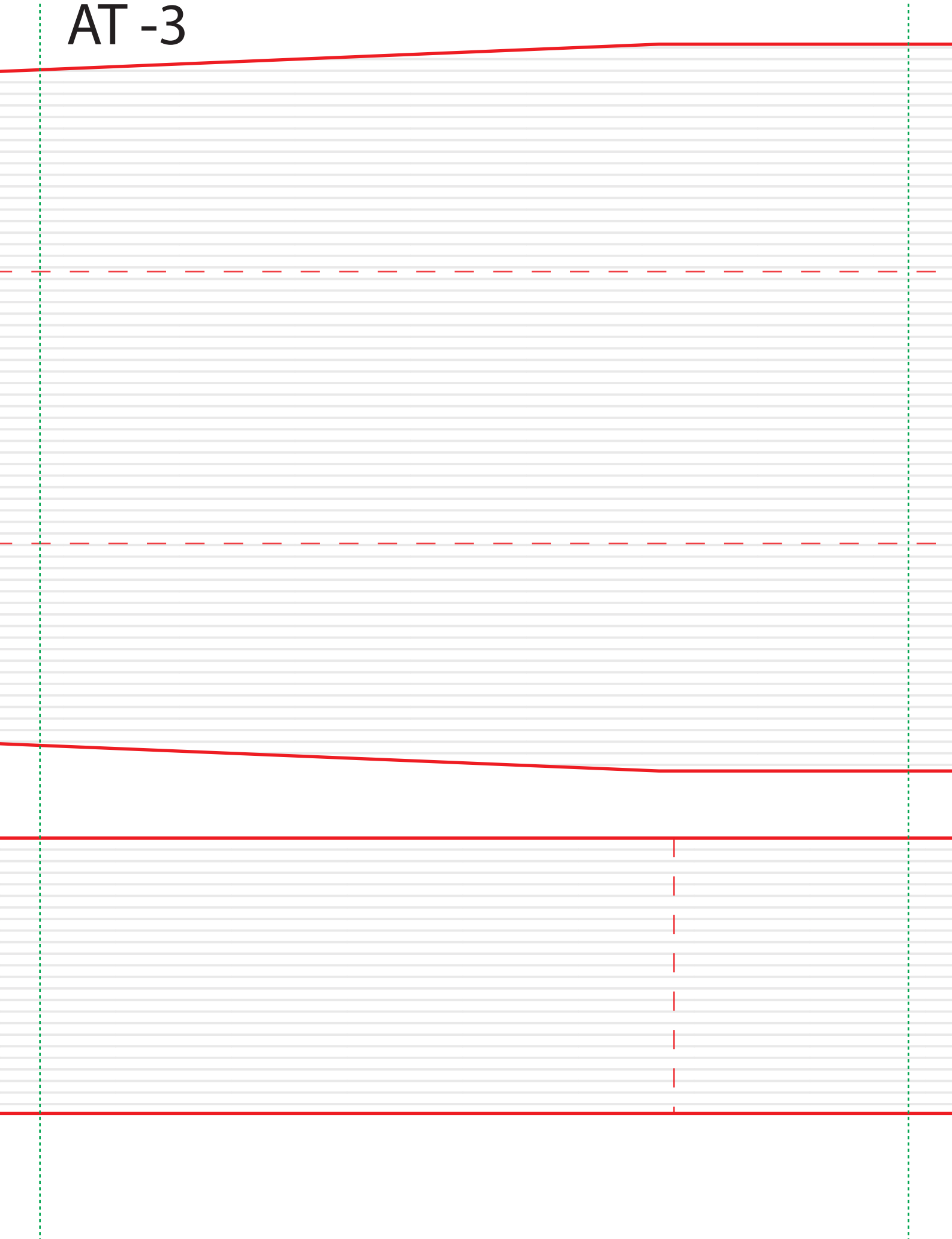

AT -4

Lined writing area (top left)

Lined writing area (middle left)

Lined writing area (bottom left)

Lined writing area (bottom left)

Lined writing area (middle right)

Lined writing area (small right)

Lined writing area (small right)

Lined writing area (small right)

BF - 1

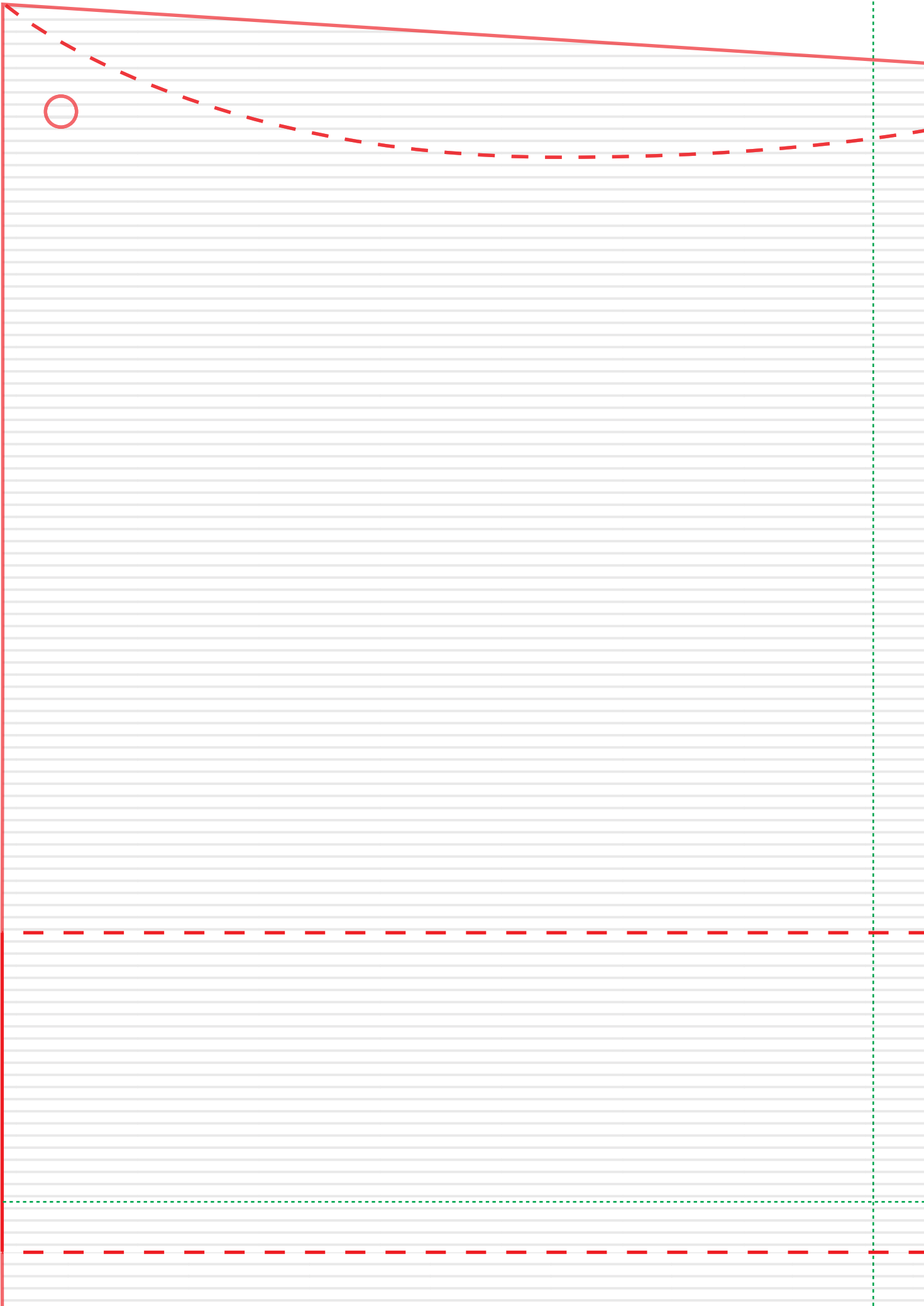

BF - 2

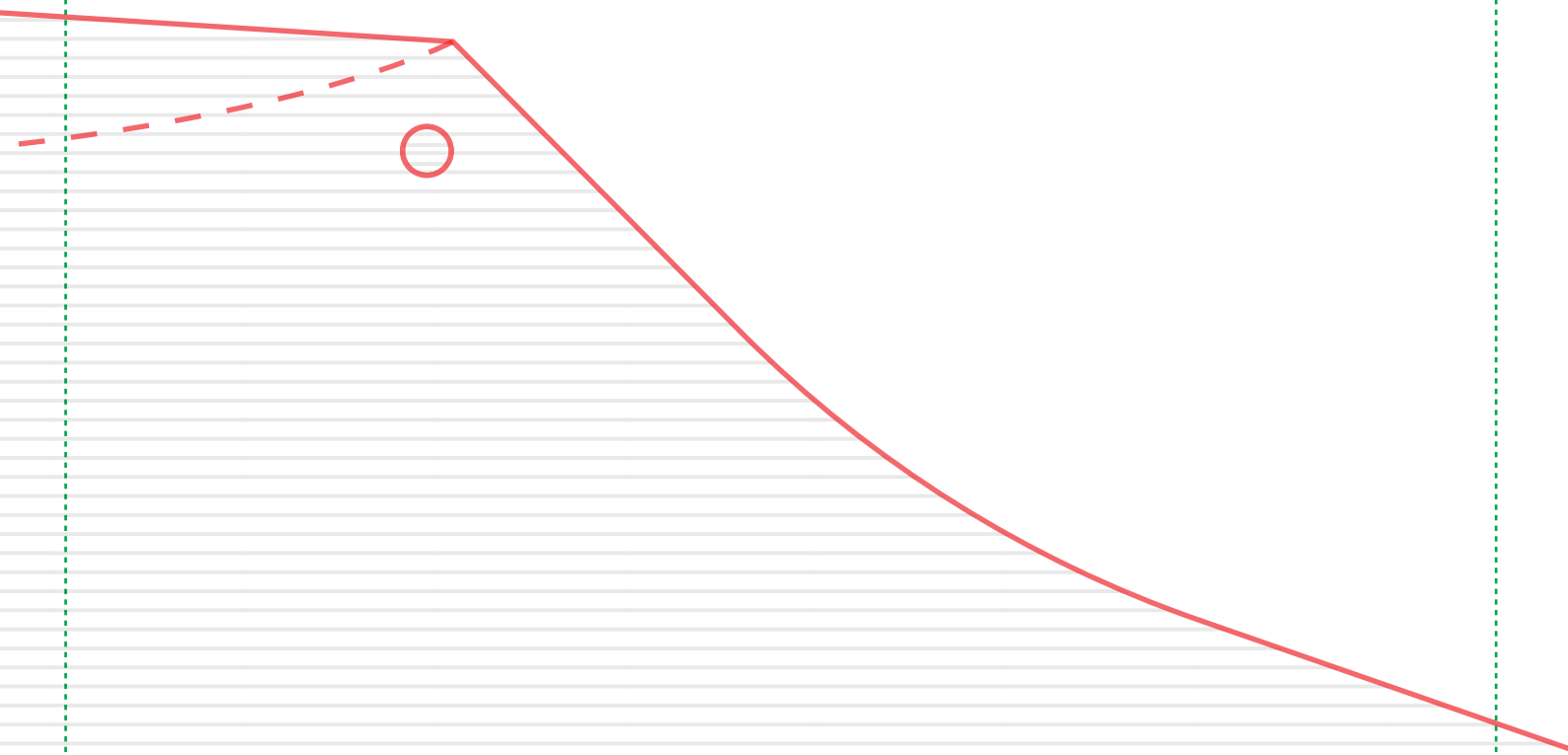

BF - 3

Fuse front top

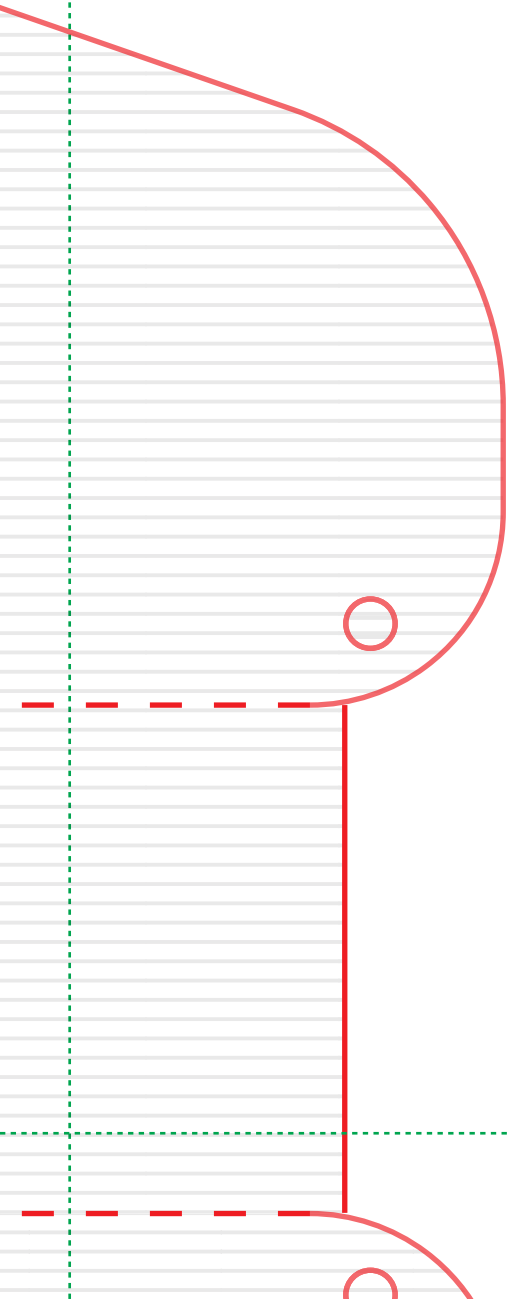

BF - 4



BF -5

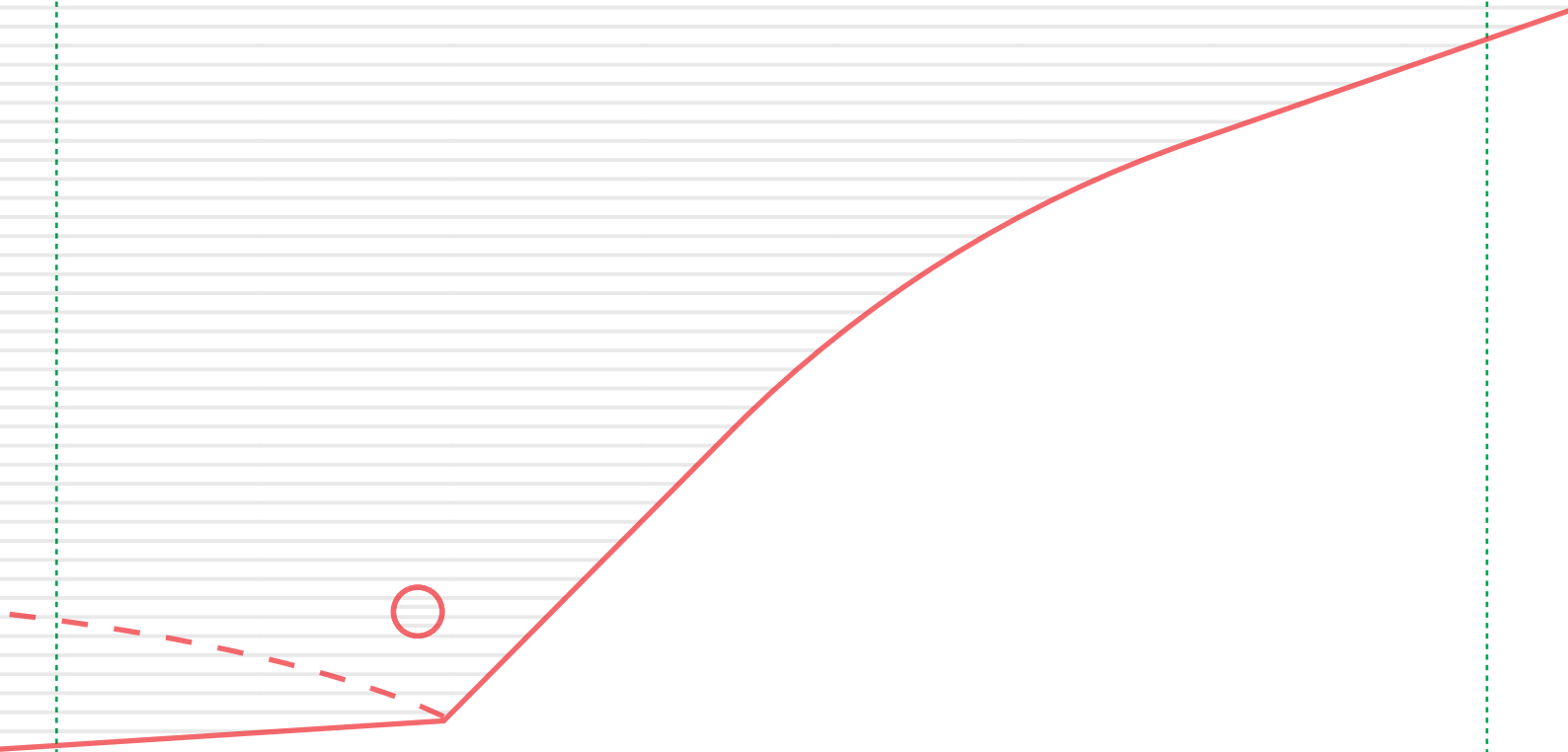

BF - 6

A small rectangular box with horizontal lines and a blue border, located at the top right of the page.A large, rounded rectangular box with horizontal lines, a red border, and a small circle at the top right. It is positioned on the left side of the page, partially overlapping a dashed red line.A large rectangular box with horizontal lines and a blue border, located in the center-right of the page.

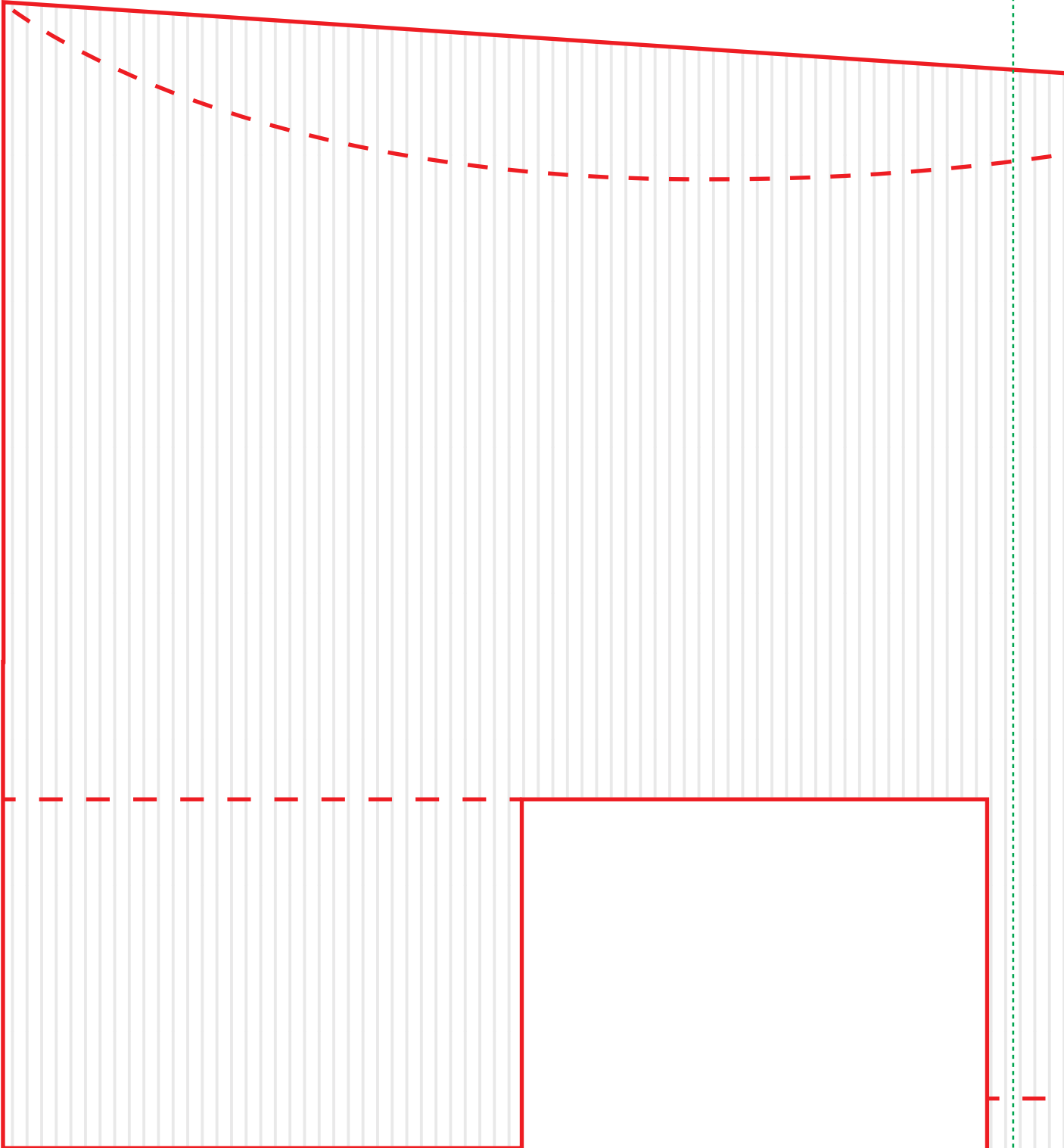

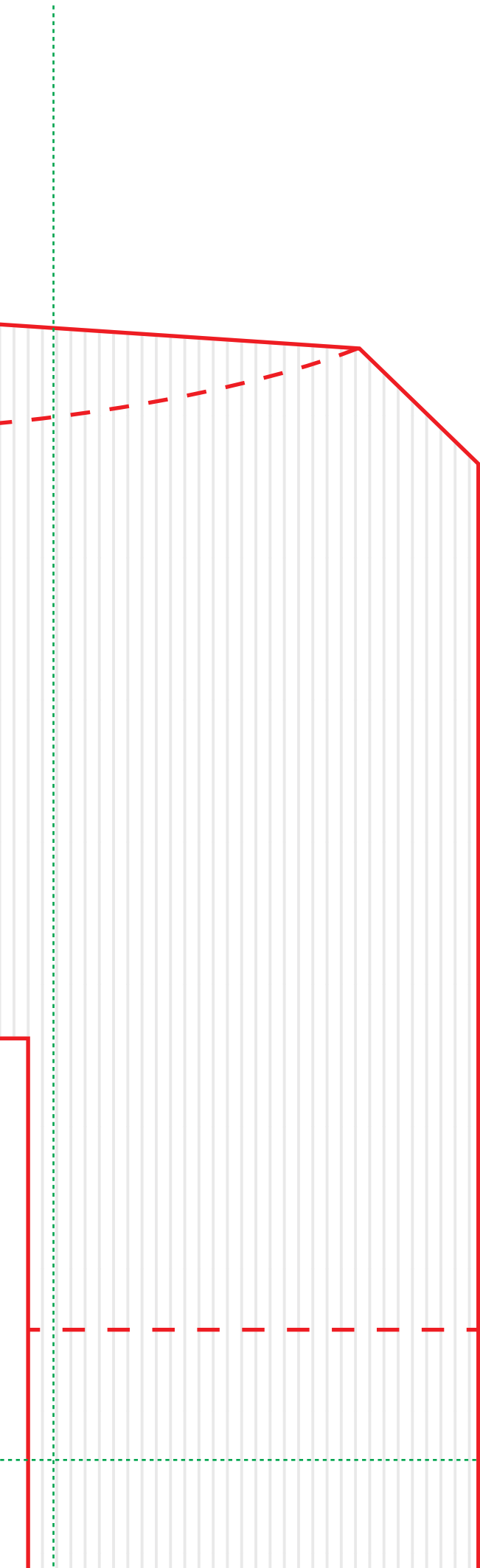

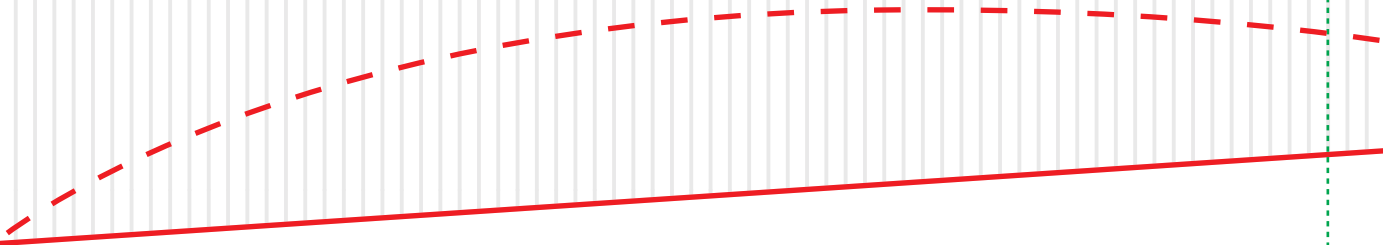
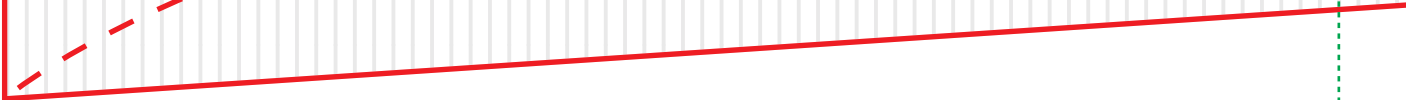

# Servo mount

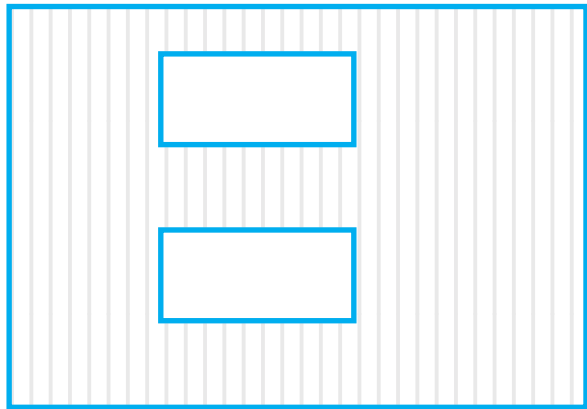

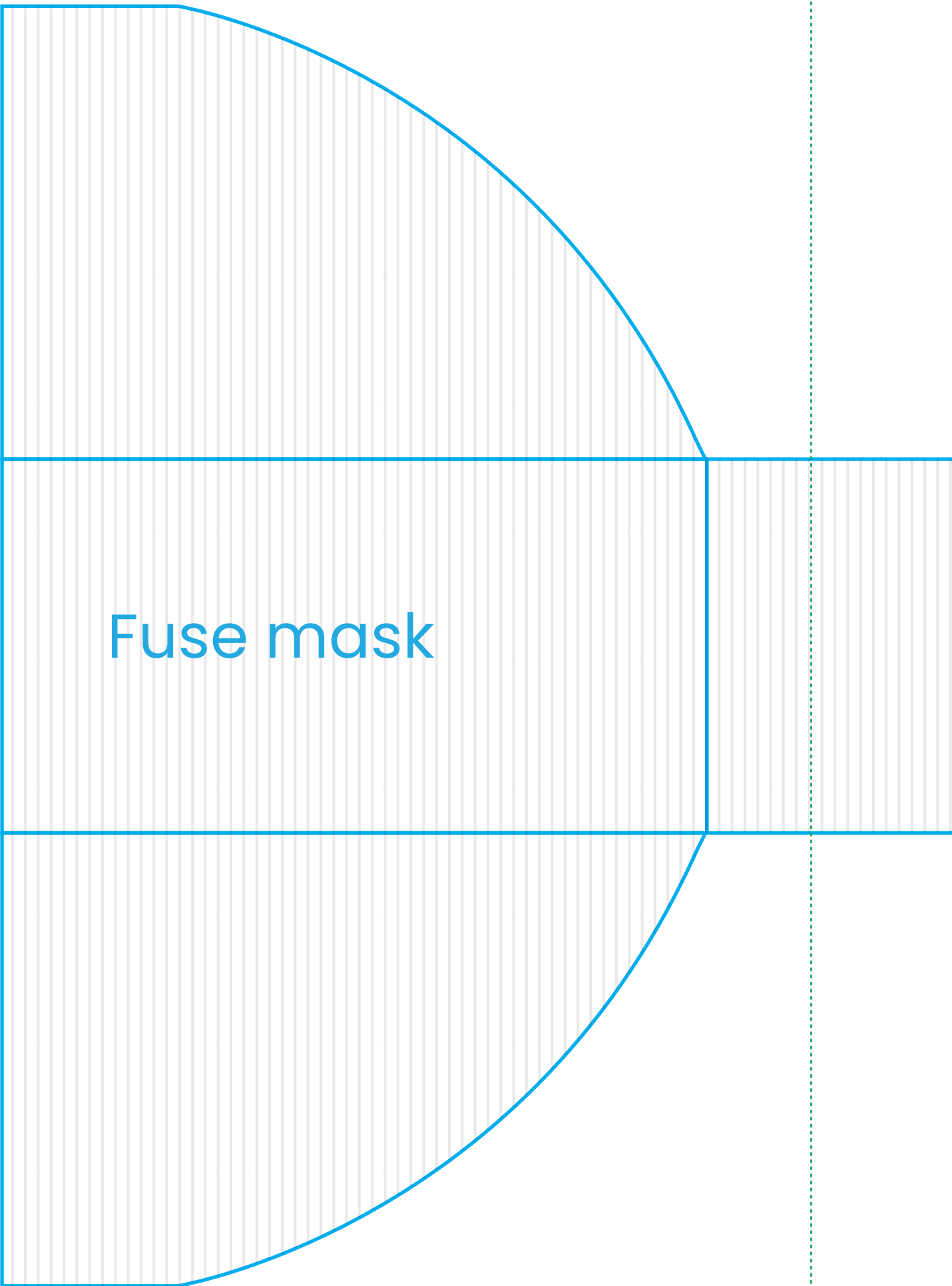

CM - 2

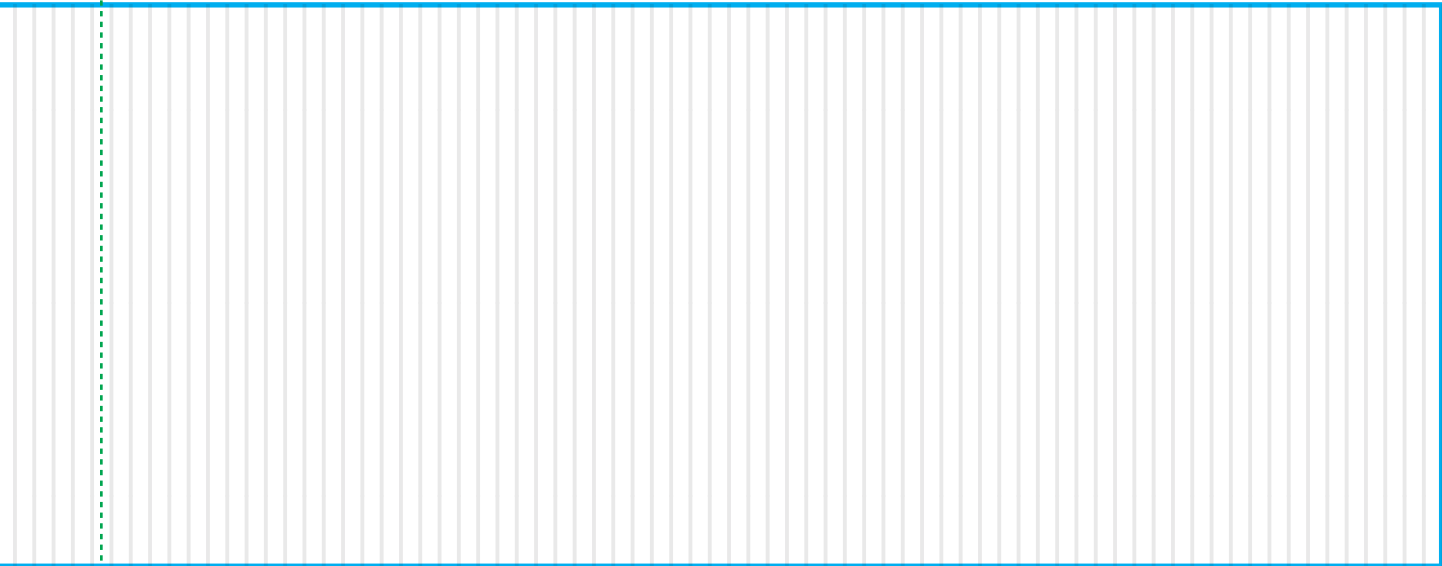

TW - 1

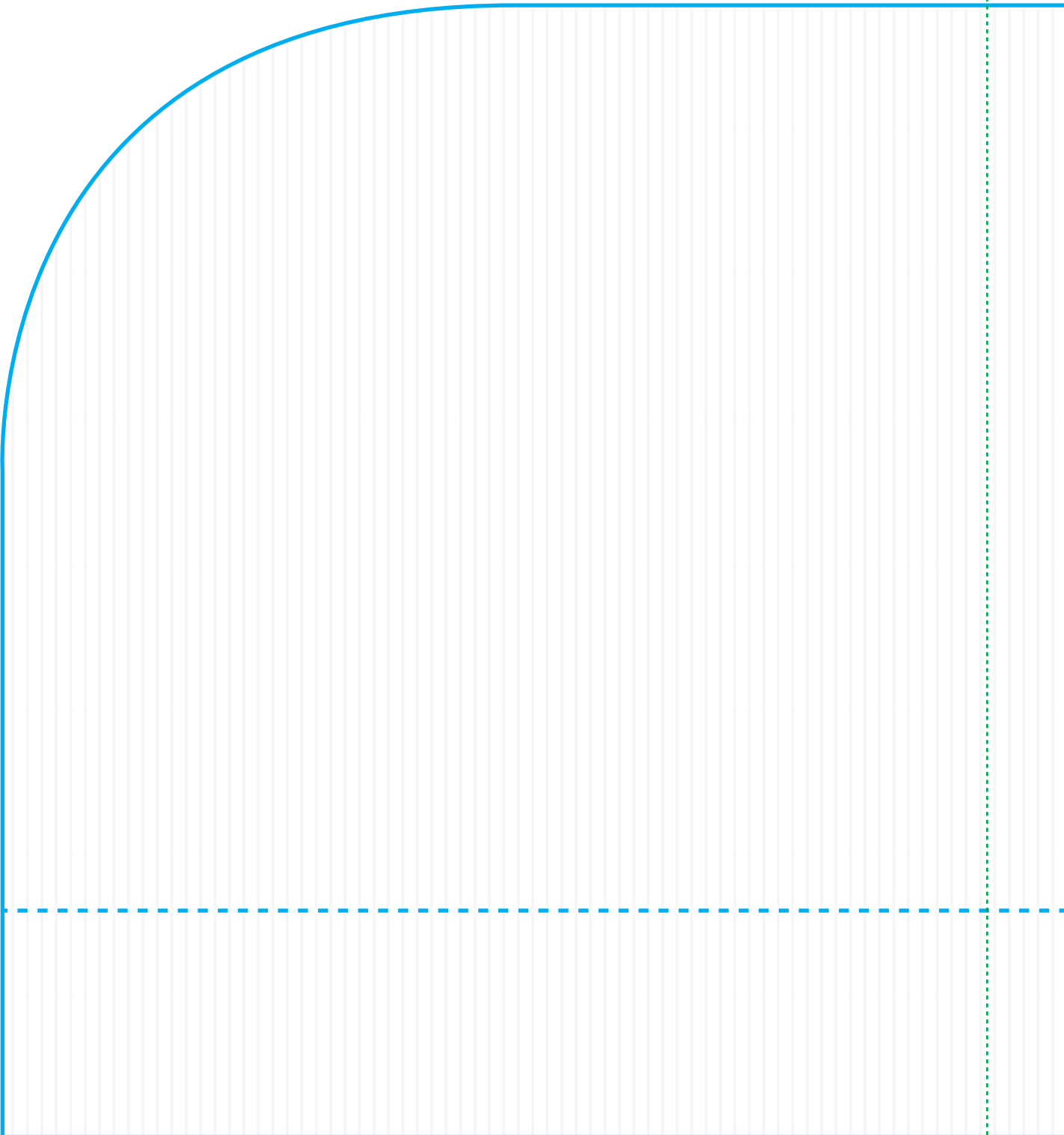

TW - 2

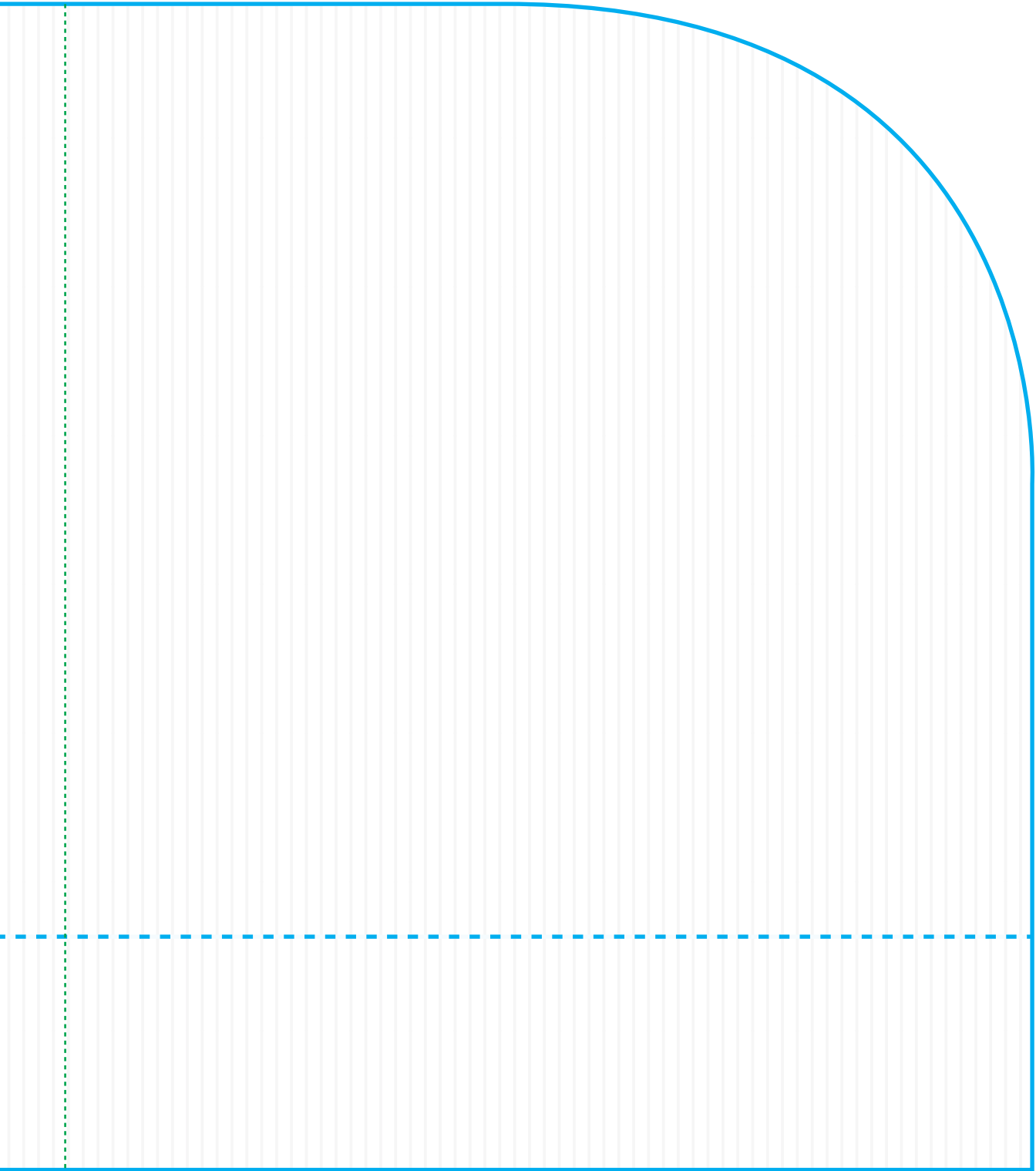

TW - 3

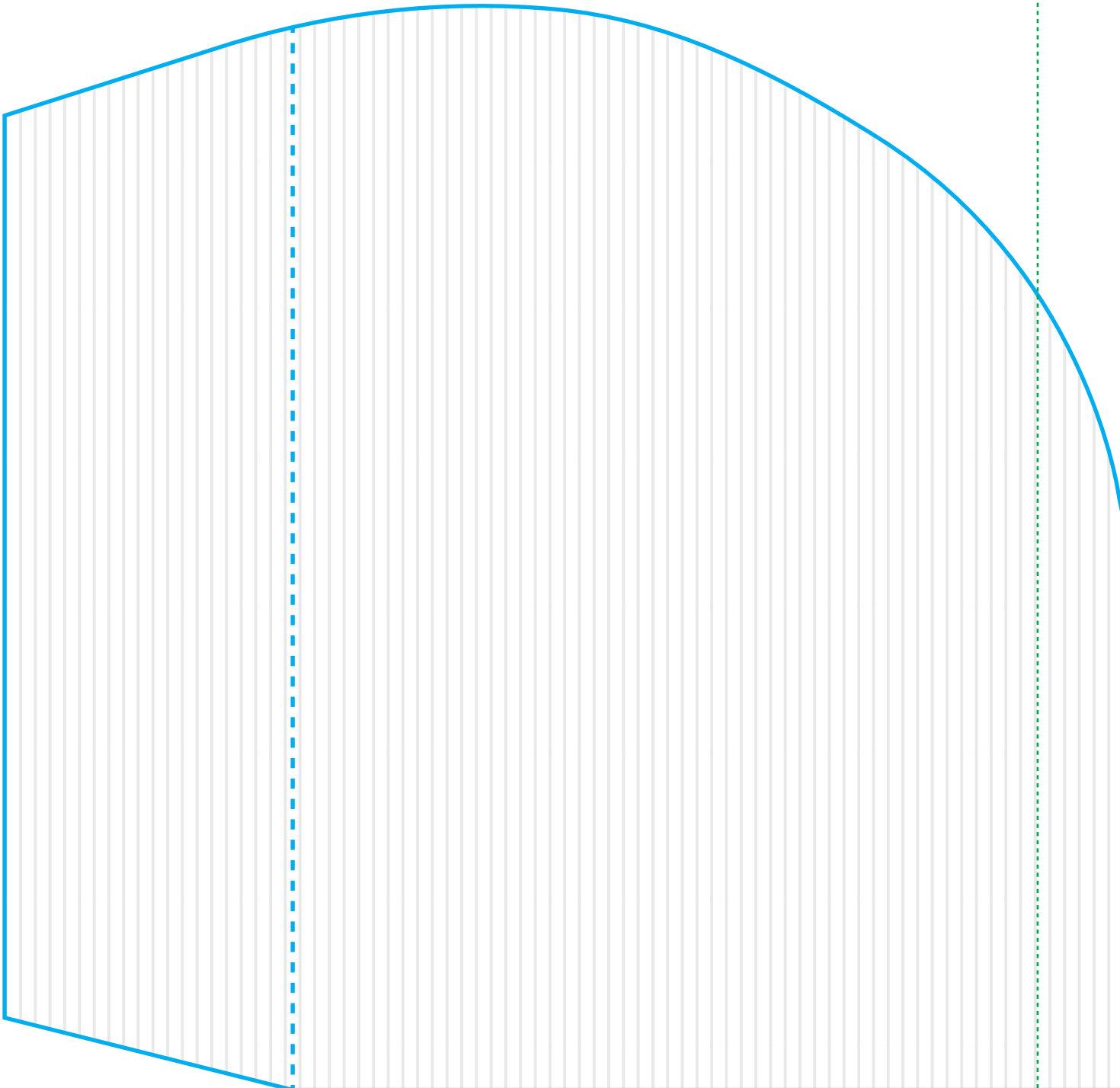

TW - 4

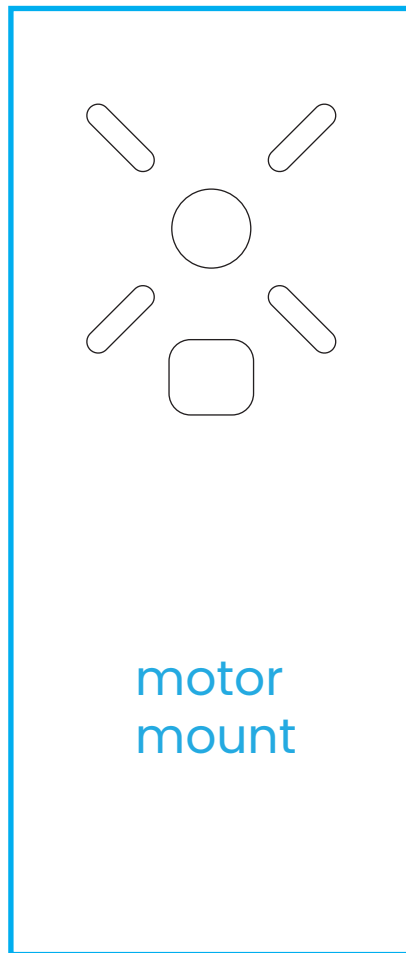
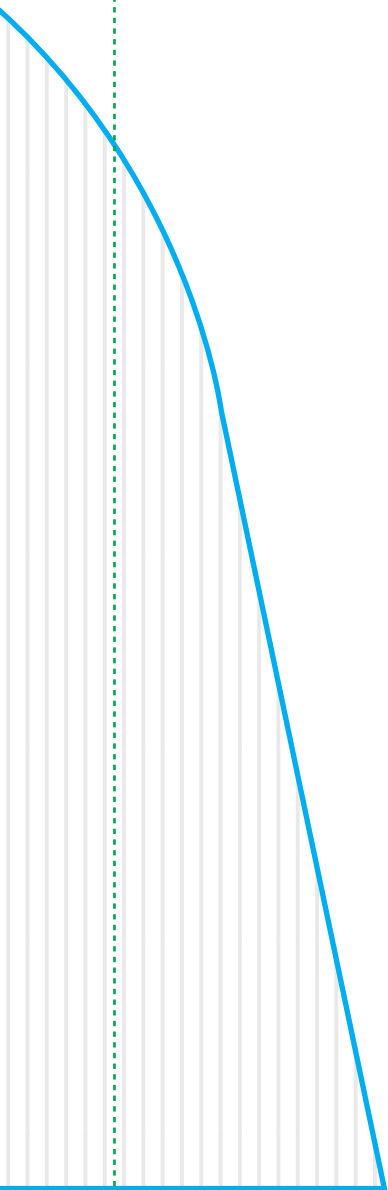

# Main wing

(Refer measurements from page 9)

**Thank you!**  
Happy Flying